

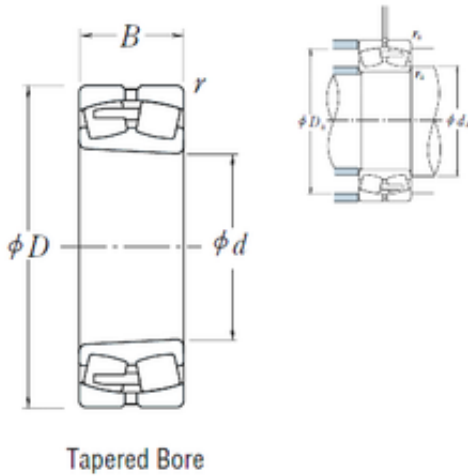

# SKF-SUDAMERICAN,S.A.

## 241/500CAK30E4 NSK Spherical Roller Bearing

Bearing No. 241/500CAK30E4



241/500CAK30E4 Bearing 2D drawings and 3D CAD models

Size	500x830x325 mm
Bore Diameter	500 mm
Outer Diameter	830 mm
Width	325 mm
d	500 mm
D	830 mm
B	325 mm
C	325 mm
r min.	7,5 mm
da min.	536 mm
Da min	703 mm
Da max.	794 mm
ra max.	6 mm
Weight	666 Kg
Basic dynamic load rating (C)	8000 kN
Basic static load rating (C0)	16000 kN
(Grease) Lubrication Speed	280 r/min
(Oil) Lubrication Speed	360 r/min
Calculation factor (e)	0,39
Calculation factor (Y0)	1,7
Calculation factor (Y2)	2,6